

INSTRUCTION MANUAL

IMPORTANT SAFEGUARDS

When using electrical equipment, basic safety precautions should always be followed, including the following:

READ AND FOLLOW ALL SAFETY INSTRUCTIONS

1. **CAUTION** – To prevent electrical shock, do not mate unit connector until installation is complete and A.C. power is supplied to the unit.
2. **CAUTION** – This fixture provides more than one power supply output source. To reduce the risk of electrical shock, disconnect both normal and emergency sources by turning off the A.C. branch circuit and by disconnecting the unit connector.
3. **CAUTION** – This is a sealed unit. The integral, high temperature Ni-Cad battery is not replaceable. Replace the entire unit when necessary and recycle or dispose of the nickel-cadmium battery properly.
4. **DO NOT USE OUTDOORS.** The **ISL-54** is for use with grounded, UL Listed, indoor fixtures. Not for use in heated air outlets or hazardous locations.
5. The **ISL-54** requires an unswitched A.C. power source of either 120 or 277 volts. Properly cap the unused A.C. lead.
6. Do not mount near gas or electric heaters.
7. The **ISL-54** and A.C. ballast **must** be on the same branch circuit.
8. The **ISL-54** should be mounted in locations and at heights where it will not readily be subjected to tampering by unauthorized personnel.
9. The **ISL-54** will cold strike and operate for 90 minutes *one* 2' to 4' T5, 17W to 30W T6, or 17W to 40W T8 linear lamp, including HO and 4 pin long compact fluorescent lamps, from 36 through 55 watts.
10. The **ISL-54** is compatible with all A.C. magnetic and electronic ballasts including multiple lamp ballasts with one lamp operating in the emergency mode.
11. The use of accessory equipment not recommended by the manufacturer may cause an unsafe condition.
12. Do not use this equipment for other than intended use.
13. Install in accordance with the National Electrical Code and local regulations.
14. Installation and servicing should be performed by qualified personnel.
15. Lighting fixture manufacturers, electricians, and end-users need to ensure product system compatibility before final installation.

SAVE THESE INSTRUCTIONS



THIS UNIT CONTAINS A
RECHARGEABLE NICKEL-
CADMIUM BATTERY. PLEASE
RECYCLE OR DISPOSE OF
PROPERLY.

INSTALLATION INSTRUCTIONS

CAUTION: Before installing, make certain the A.C. power is off and the ISL-54 unit connector is disconnected.

1. MOUNTING THE ISL-54

Remove the ballast channel cover. Mount the **ISL-54** in the ballast channel at least $\frac{1}{2}$ " away from the A.C. ballast(s).

When battery packs are remote mounted, consult Customer Service for the maximum allowable distance between the battery pack and the lamp.

2. WIRING

Refer to the wiring diagrams on the back page for the appropriate wiring of lamp(s) and ballast. Install in accordance with the National Electrical Code and local regulations. For additional wiring diagrams consult Customer Service.

3. INSTALLING THE THREADED BODY TEST SWITCH (TBTS)

Recessed Troffer Fixture – Select a convenient location with proper clearance in the ballast cover and drill or punch a $\frac{7}{8}$ " hole ($\frac{1}{2}$ " knockout). Insert the $\frac{7}{8}$ " bushing into the hole. Push the plastic tube through the bushing. Route the leads of the **TBTS** through the plastic tube. Connect the LED wires from the unit to the **TBTS** (Red/Black or Red w/tag to Red, and White/Red to White). Push the entire assembly back into the tube until the lens collar rests against the plastic tube. The plastic tube should be adjusted so that the **TBTS** is within $\frac{1}{4}$ " of the fixture lens. The **TBTS** must be visible after installation. Refer to *Illustration 1*.

Linear Fixture – Select a convenient location on the fixture so the **TBTS** can be seen after installation. Allow for proper clearance inside the fixture and drill or punch a $\frac{1}{2}$ " hole. Remove the nut from the **TBTS**. Push the **TBTS** housing into the $\frac{1}{2}$ " hole and secure with the nut. Connect the LED wires from the unit to the **TBTS** (Red/Black or Red w/tag to Red, and White/Red to White). Refer to *Illustration 2*.

Illustration 1

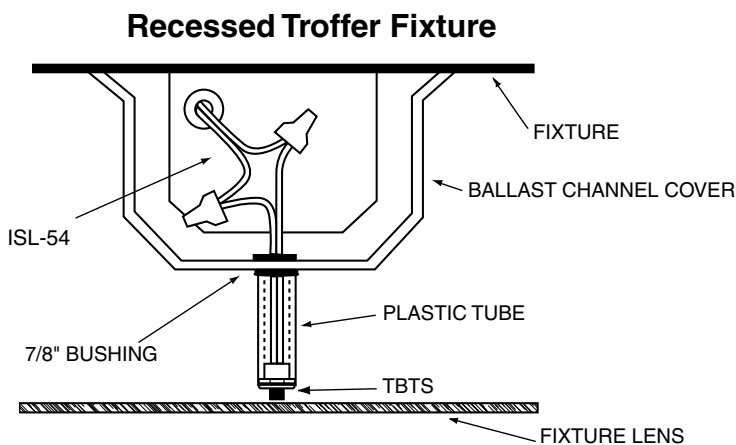
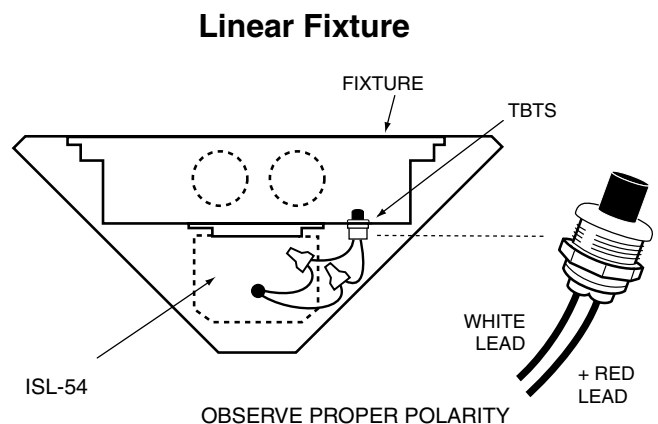

Illustration 2



4. WIRING THE A.C. INPUT

- The **ISL-54** and A.C. ballast **must** be on the same branch circuit.
- The **ISL-54** requires an **unswitched** A.C. power source of either 120 or 277 volts. Select the proper voltage lead and cap the unused lead.
- When the **ISL-54** is used with a switched fixture, the A.C. input to the **ISL-54** must be connected ahead of the fixture switch. Refer to *Illustration 3* for switched and unswitched fixture wiring diagrams.

5. BALLAST WIRING BLOCK DIAGRAM

Illustration 3

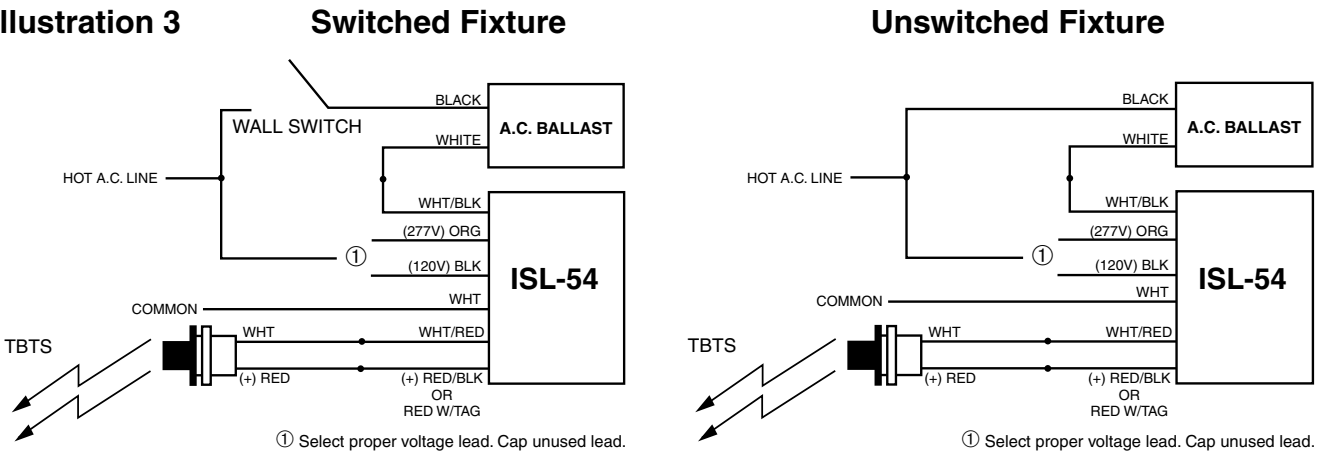

6. LABELS

Attach the appropriate labels adjacent to the **TBTS**. Annotate Re-lamping label for lamp type and wattage. The Caution and the Re-lamping labels must be on the fixture in a readily visible location to anyone attempting to service the fixture.

7. COMPLETING INSTALLATION

When the installation is complete, switch the A.C. power on and join the **ISL-54** unit connector.

OPERATION

Normal Mode – A.C. power is present. The A.C. ballast operates the fluorescent lamp(s) as intended. The **ISL-54** is in the standby charging mode. The **TBTS** will be lit providing a visual indication that the battery is being charged.

Emergency Mode – The A.C. power fails. The **ISL-54** senses the A.C. power failure and automatically switches to the *Emergency Mode*. One lamp is illuminated, at reduced output, for a minimum of 90 minutes. When the A.C. power is restored, the **ISL-54** switches the system back to the *Normal Mode* and resumes battery charging. See page 1 of the Instruction Manual.

TESTING & MAINTENANCE

Pressing the red lens on the **TBTS** turns off the light on the **TBTS** and forces the unit into the emergency mode, interrupting power to the designated A.C. ballast. The emergency lamp is now being lit by the **ISL-54** unit. After releasing the **TBTS**, the fixture returns to normal operation after a momentary delay. To simulate a “BLACK OUT” use the circuit breaker to turn off A.C. power.

Initial Testing – Allow the unit to charge approximately 1 hour, then press the **TBTS** to conduct a short discharge test. Allow a 24 hour charge before conducting a one hour test.

The **ISL-54** is a maintenance free unit, however, periodic inspection and testing is required. NFPA 101, Life Safety Code, outlines the following schedule:

Monthly – Insure that the **TBTS** is illuminated. Conduct a 30 second discharge test by depressing the **TBTS**. One lamp should operate at reduced output.

Annually – Insure that the **TBTS** is illuminated. Conduct a full 1½ hour discharge test. The unit should operate as intended for the duration of the test.

“Written records of testing shall be kept by the owner for inspection by the authority having jurisdiction.”

SERVICING SHOULD BE PERFORMED BY QUALIFIED PERSONNEL.
Consult Customer Service or visit www.iotaengineering.com for current warranty information.

TYPICAL WIRING DIAGRAMS

For wiring diagrams of ballasts not shown, consult our Customer Service.

Wiring and Troubleshooting Tips are available on-line at <http://www.iotaengineering.com/wiringtips.pdf>

1. ONE LAMP RAPID START BALLAST

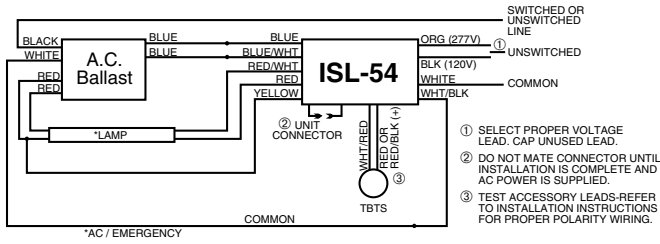

6. FOUR LAMP RAPID START BALLAST

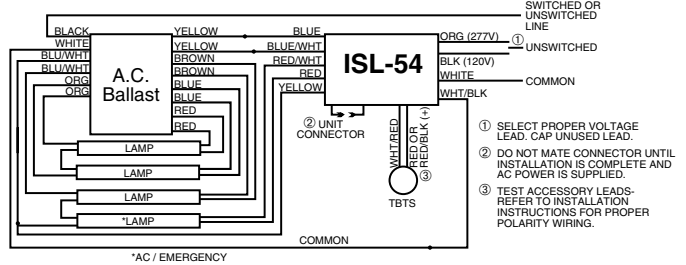

2. TWO LAMP RAPID START BALLAST

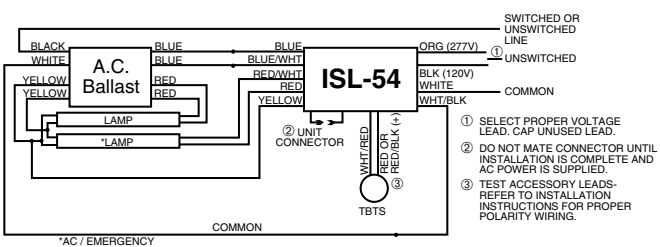

7. ONE LAMP INSTANT START BALLAST

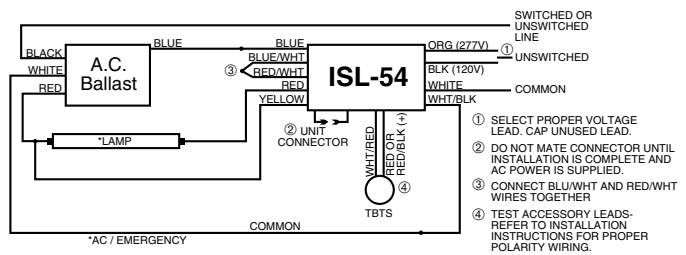

3. TWO LAMP INSTANT START BALLAST

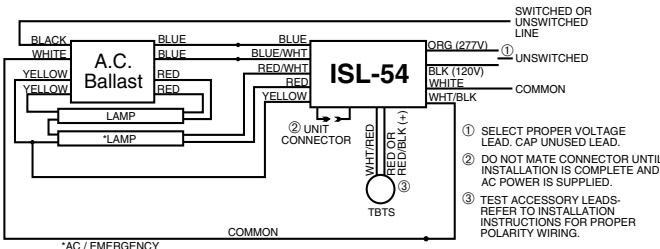

8. TWO LAMP INSTANT START BALLAST

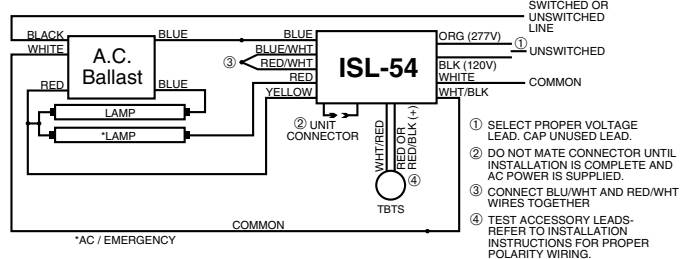

4. THREE LAMP RAPID START BALLAST

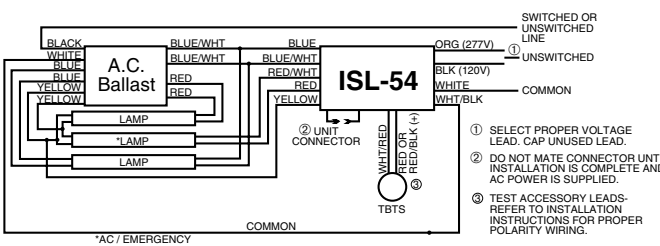

9. THREE LAMP INSTANT START BALLAST

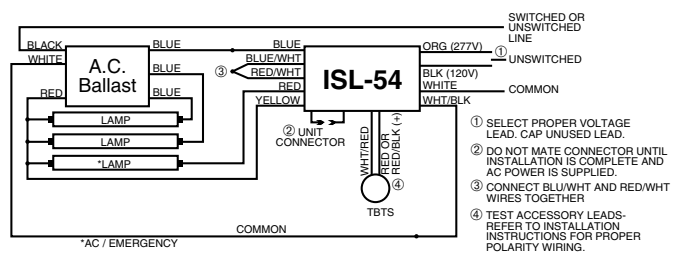

5. THREE LAMP RAPID START BALLAST

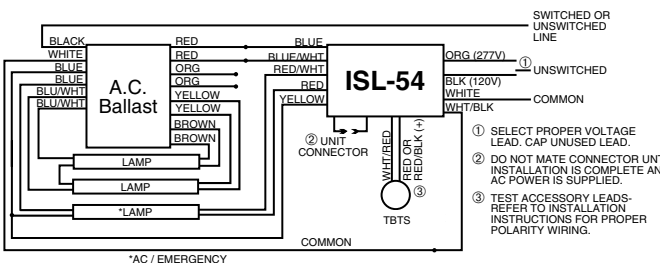

10. FOUR LAMP INSTANT START BALLAST

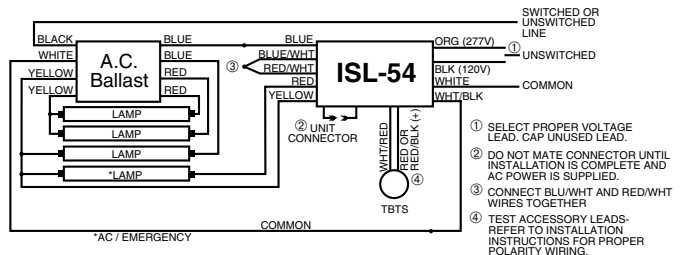

TYPICAL WIRING DIAGRAMS

For Osram/Sylvania Rapid Start Ballasts

For wiring diagrams of ballasts not shown, consult our Customer Service.

Wiring and Troubleshooting Tips are available on-line at <http://www.iotaengineering.com/wiringtips.pdf>

1. ONE LAMP RAPID START BALLAST

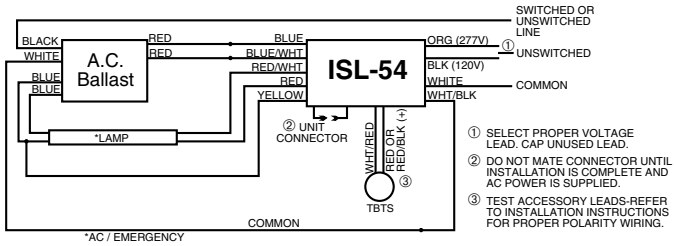

3. TWO LAMP RAPID START BALLAST

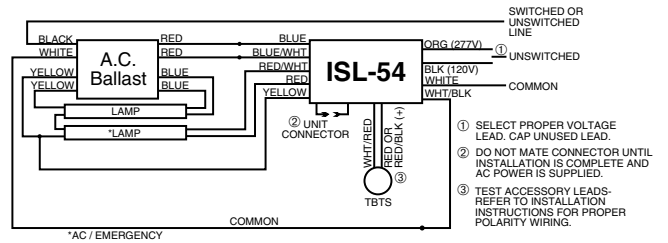

2. TWO LAMP RAPID START BALLAST

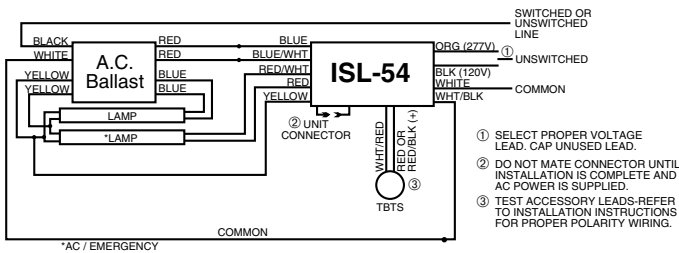

4. THREE LAMP RAPID START BALLAST

