



P.O. BOX 11846 TUCSON, AZ 85734
(520) 294-3292 • FAX (520) 741-2837
www.iotaengineering.com

I-320

SERIES AC
EMERGENCY
LIGHTING EQUIPMENT

INSTRUCTION MANUAL

IMPORTANT SAFEGUARDS

When using electrical equipment, basic safety precautions should always be followed, including the following:

READ AND FOLLOW ALL SAFETY INSTRUCTIONS

1. **CAUTION** – To prevent electrical shock, do not mate unit connector until installation is complete and A.C. power is supplied to the unit.
2. **CAUTION** – This fixture provides more than one power supply output source. To reduce the risk of electrical shock, disconnect both normal and emergency sources by turning off the A.C. branch circuit and by disconnecting the unit connector.
3. **CAUTION** – This is a sealed unit. The integral, high temperature Ni-Cad battery is not replaceable. Replace the entire unit when necessary and recycle or dispose of the nickel-cadmium battery properly.
4. **DO NOT USE OUTDOORS.** The **I-320** is for use with grounded, UL Listed, damp location rated, indoor fixtures. Not for use in heated air outlets or hazardous locations.
5. The **I-320** requires an unswitched A.C. power source of either 120 or 277 volts. Properly cap the unused A.C. lead.
6. When the **I-320** is installed on the same branch circuit, refer to Illustration 3, Figures A and B for input wiring. When installed on separate branch circuits, refer to Illustration 3, Figures C and D for input wiring. Per NEC, the **I-320** and A.C. ballast must be on the same panel board.
7. Do not mount near gas or electric heaters.
8. The **I-320** should be mounted in locations and at heights where it will not readily be subjected to tampering by unauthorized personnel.
9. The **I-320** will cold strike and operate one 14W through 54W T5 or 2'-4' T8 instant start or rapid start fluorescent lamp, including energy saving and 4-pin compact lamps for 90 minutes.
10. The **I-320** is compatible with most A.C. ballasts (including multiple lamp) as follows:
Magnetic ballasts – one lamp emergency operation.
Electronic ballasts – one lamp emergency operation.
11. Suitable for use in damp locations and in enclosed and gasketed fixtures.
12. For use in 0° C minimum, 50° C maximum ambient temperatures.
13. The use of accessory equipment not recommended by the manufacturer may cause an unsafe condition, will void warranty, and result in non-compliance with UL specifications.
14. Do not use this equipment for other than intended use.
15. Install in accordance with the National Electrical Code and local regulations.
16. Installation and servicing should be performed by qualified personnel.
17. Lighting fixture manufacturers, electricians, and end-users need to ensure product system compatibility before final installation.

SAVE THESE INSTRUCTIONS



THIS UNIT CONTAINS A
RECHARGEABLE NICKEL-CADMIUM BATTERY.
PLEASE RECYCLE OR DISPOSE OF PROPERLY.

INSTALLATION INSTRUCTIONS

CAUTION: Before installing, make certain the A.C. power is off and the I-320 unit connector is disconnected.

1. LAMPS OPERATED

The **I-320** can be used with most 2'-4' lamps. Refer to the chart on the right for the type of lamp operated in emergency mode. Contact Customer Service for answers about specific lamps.

*The 6" violet leads provide the lamp selection option. The unit is shipped from the factory with the leads disconnected and capped. When used with particular lamp types, violet leads should be connected to one another. Refer to chart for lamp selection options.

OPTION	LAMP TYPE	EMERGENCY OPERATION	*VIOLET LEADS
1	2'-4' T8 Single Pin & Bipin	One Lamp	Connected
2	2'-4' 14W-24W, 39W T5	One Lamp	Connected
3	2'-4' 28W or 54W T5	One Lamp	Disconnected
4	13W-32W 4-Pin Compact	One Lamp	Connected
5	42W 4-Pin Compact	One Lamp	Disconnected

2. MOUNTING THE I-320

Remove the ballast channel cover. Mount the **I-320** in the ballast channel at least 1/2" away from the A.C. ballast(s)

When battery packs are remote mounted, consult Customer Service for the maximum allowable distance between the battery pack and lamp.

3. WIRING

Refer to the wiring diagrams on the back page for the appropriate wiring of lamp(s) and ballast. Install in accordance with the National Electrical Code and local regulations. For additional wiring diagrams consult Customer Service.

4. INSTALLING THE CHARGE INDICATOR

Recessed Troffer Fixture – Select a convenient location with proper clearance in the ballast cover and drill or punch a 7/8" hole (1/2" knockout). Insert the 7/8" bushing into the hole. Push the plastic tube through the bushing. Route the leads of the **LED** through the plastic tube. Reconnect the leads to the housing, observing proper polarity (Red/Black or Red lead w/connector to positive (+) red tab). Push the entire assembly back into the tube until the lens collar rests against the plastic tube. The plastic tube should be adjusted so that the **Charge Indicator** is within 1/4" of the fixture lens. The **Charge Indicator** must be visible after installation. Refer to *Illustration 1*.

Strip Fixture – Select a convenient location on the fixture so the **Charge Indicator** can be seen after installation. Allow for proper clearance inside the fixture and drill or punch a 1/2" hole. Disconnect the leads from the **LED** housing. Push the **LED** housing into the 1/2" hole until it is firmly locked in place. Reconnect the leads, observing proper polarity (Red/Black or Red lead w/connector to positive (+) red tab). Refer to *Illustration 2*.

ATTENTION: Only connect the I-320 to the Charge Indicator LED supplied with the unit. The LED must be replaced when replacing the unit.

Illustration 1 Recessed Troffer Fixture

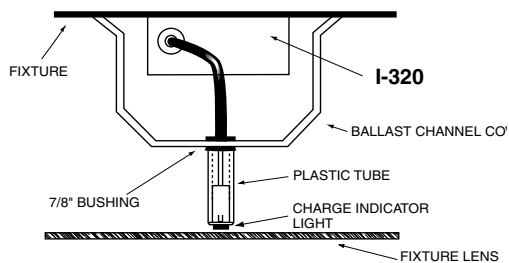
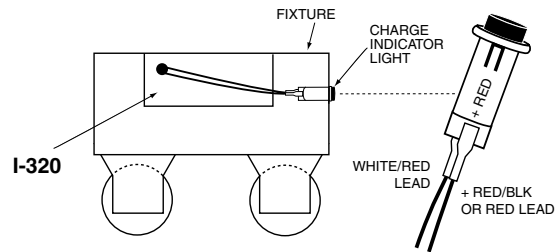

Illustration 2 Strip Fixture



OBSERVE PROPER POLARITY

5. INSTALLING THE TEST SWITCH

The **Test Switch** should be mounted on the ballast channel cover of a recessed troffer, or on the side of a strip fixture, preferably adjacent to the **Charge Indicator**. Drill or punch a 1/2" mounting hole.

6. WIRING THE A.C. INPUT

- When the **I-320** is installed on the same branch circuit, refer to *Illustration 3*, Figures A and B for input wiring. When installed on separate branch circuits, refer to *Illustration 3*, Figures C and D for input wiring. Per NEC, the **I-320** and A.C. ballast must be on the same panel board.
- The **I-320** requires an **unswitched** A.C. power source of either 120 or 277 volts. Select the proper voltage lead and cap the unused lead.
- When the **I-320** is used with a switched fixture, the A.C. input to the **I-320** must be connected ahead of the fixture switch. Refer to *Illustration 3* for switched and unswitched fixture wiring diagrams.

7. BALLAST WIRING BLOCK DIAGRAM

Illustration 3

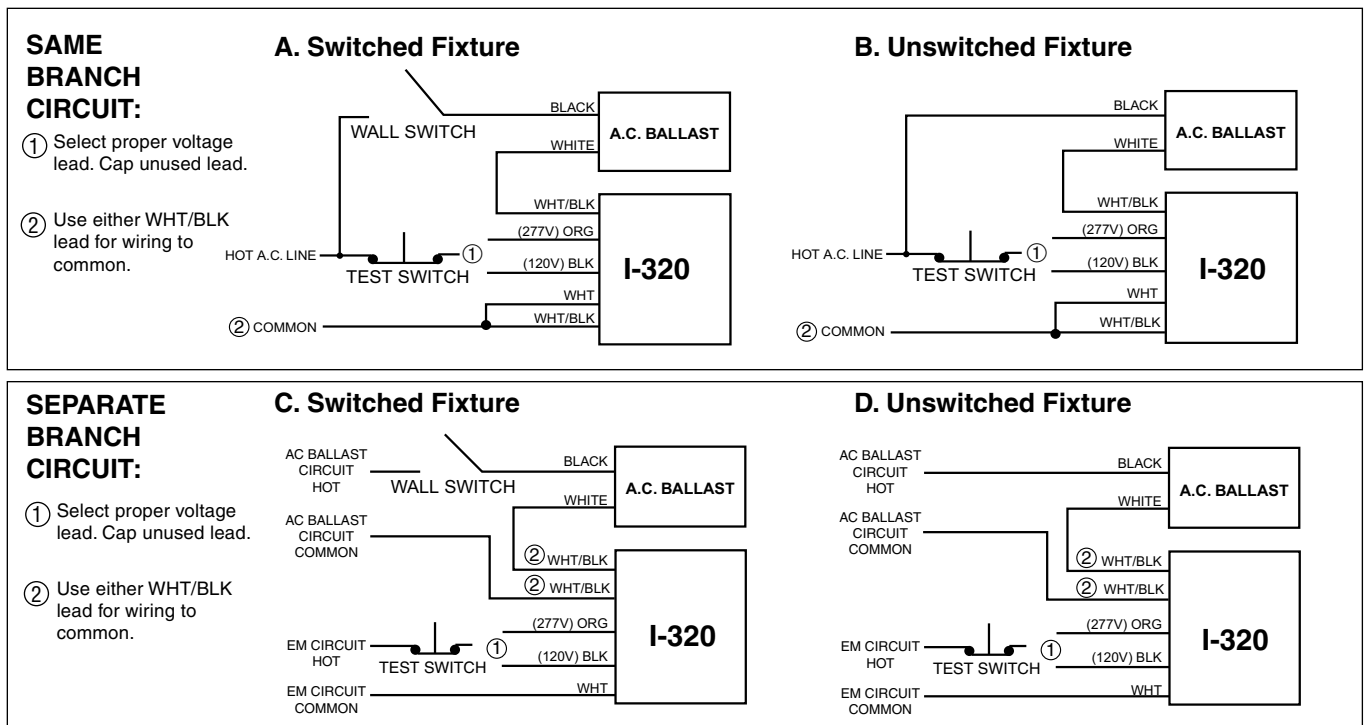

8. LABELS

Attach the appropriate labels adjacent to the **Charge Indicator**. Annotate Re-lamping label for lamp type and wattage. The Caution and the Re-lamping labels must be on the fixture in a readily visible location to anyone attempting to service the fixture.

9. COMPLETING INSTALLATION

When the installation is complete, switch the A.C. power on and join the **I-320** unit connector.

OPERATION

Normal Mode – A.C. power is present. The A.C. ballast operates the fluorescent lamp(s) as intended. The **I-320** is in the standby charging mode. The **Charge Indicator** will be lit providing a visual indication that the battery is being charged.

Emergency Mode – The A.C. power fails. The **I-320** senses the A.C. power failure and automatically switches to the *Emergency Mode*. One is illuminated, at reduced output, for a minimum of 90 minutes. When the A.C. power is restored, the **I-320** switches the system back to the *Normal Mode* and resumes battery charging. See page 1 of the Instruction Manual.

TESTING & MAINTENANCE

Pressing and holding the **Test Switch** for a minimum of five seconds turns off the light on the **Charge Indicator** and forces the unit into emergency mode, interrupting power to the designated A.C. ballast. The emergency lamp is now being lit by the **I-320** unit. After releasing the **Test Switch**, the fixture returns to normal operation after a momentary delay. To simulate a “BLACK OUT” use the circuit breaker to turn off A.C. power.

Initial Testing – Allow the unit to charge approximately 1 hour, then press and hold the **Test Switch** for a **minimum of five seconds** to conduct a short discharge test. Allow a 24 hour charge before conducting a one hour test.

The **I-320** is a maintenance free unit, however, periodic inspection and testing is required. NFPA 101, Life Safety Code, outlines the following schedule:

Monthly – Insure that the **Charge Indicator** is illuminated. Conduct a 30 second discharge test by depressing the **Test Switch**. One lamp should operate at reduced output.

Annually – Insure that the **Charge Indicator** is illuminated. Conduct a full 1½ hour discharge test. The unit should operate as intended for the duration of the test.

“Written records of testing shall be kept by the owner for inspection by the authority having jurisdiction.”

SERVICING SHOULD BE PERFORMED BY QUALIFIED PERSONNEL.

Consult Customer Service or visit www.iotaengineering.com for current warranty information.

TYPICAL WIRING DIAGRAMS

For wiring diagrams of ballasts not shown, consult our Customer Service.

Wiring and Troubleshooting Tips are available on-line at <http://www.iotaengineering.com/wiringtips.pdf>

1. ONE LAMP RAPID START BALLAST

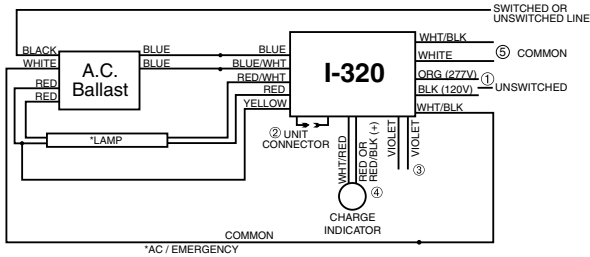

5. ONE LAMP INSTANT START BALLAST

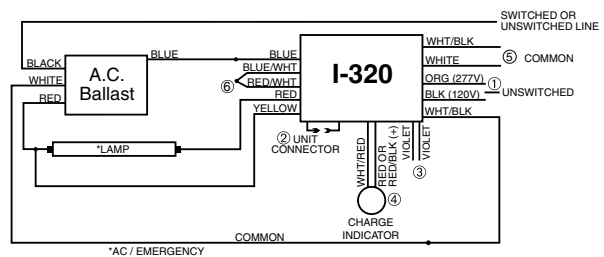

2. TWO LAMP RAPID START BALLAST

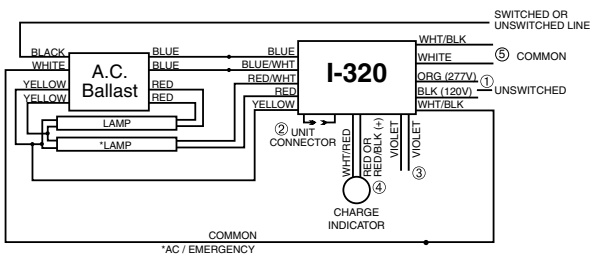

6. TWO LAMP INSTANT START BALLAST

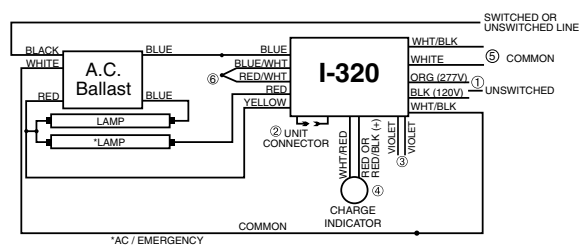

3. TWO LAMP RAPID START BALLAST

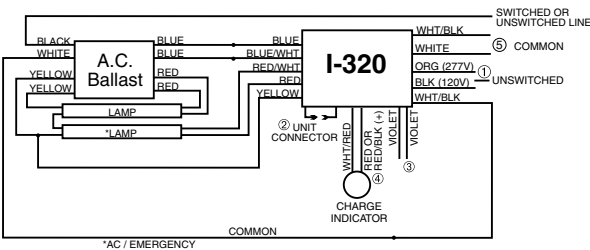

7. THREE LAMP INSTANT START BALLAST

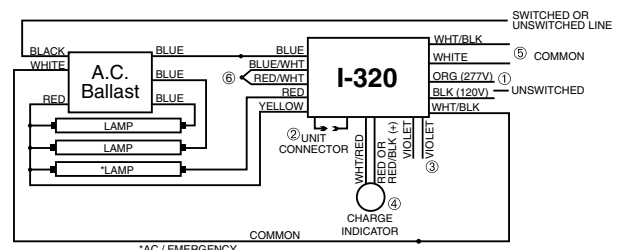

4. THREE LAMP RAPID START BALLAST

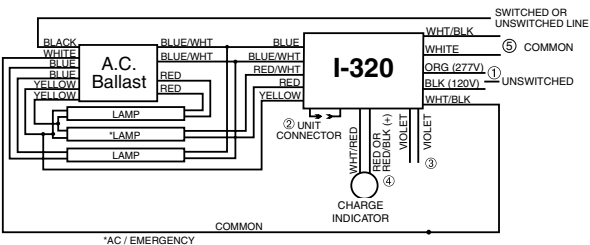

8. FOUR LAMP INSTANT START BALLAST

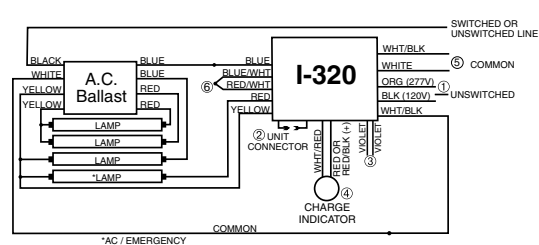

① SELECT PROPER VOLTAGE LEAD. CAP UNUSED LEAD. REFER TO AC INPUT WIRING ON ILLUSTRATION 3 OF INSTALLATION MANUAL FOR PROPER INPUT CIRCUIT WIRING.

② DO NOT MATE CONNECTOR UNTIL INSTALLATION IS COMPLETE AND AC POWER IS SUPPLIED.

③ LAMP SELECTOR LEADS—REFER TO INSTALLATION INSTRUCTIONS, LAMPS OPERATION SECTION FOR VARIOUS OPTIONS

④ TEST ACCESSORY LEADS-REFER TO INSTALLATION INSTRUCTIONS FOR PROPER POLARITY WIRING.

⑤ USE EITHER WHT/BLK LEAD FOR WIRING THE COMMON. REFER TO AC INPUT WIRING ON ILLUSTRATION 3 OF INSTALLATION MANUAL.

⑥ CONNECT BLU/WHT AND RED/WHT WIRES TOGETHER

ADDITIONAL WIRING DIAGRAMS

For wiring diagrams of ballasts not shown, consult our Customer Service.

Wiring and Troubleshooting Tips are available on-line at <http://www.iotaengineering.com/wiringtips.pdf>

1. THREE LAMP RAPID START BALLAST

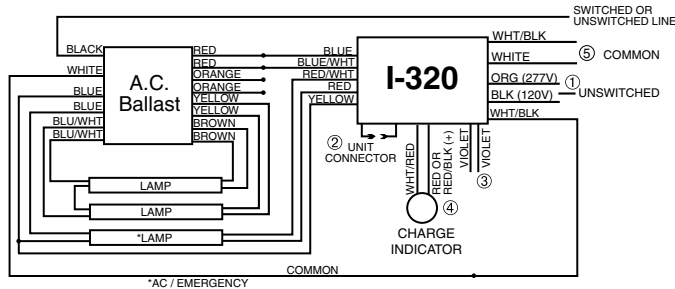

2. THREE LAMP RAPID START BALLAST

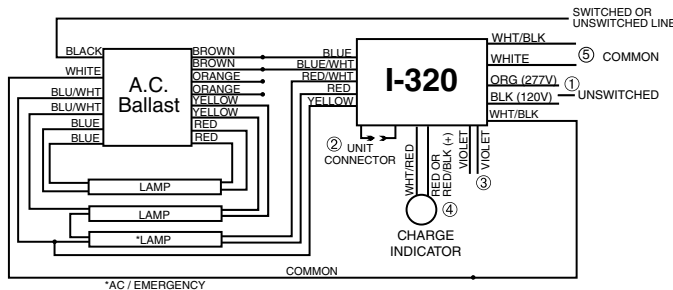

3. FOUR LAMP RAPID START BALLAST

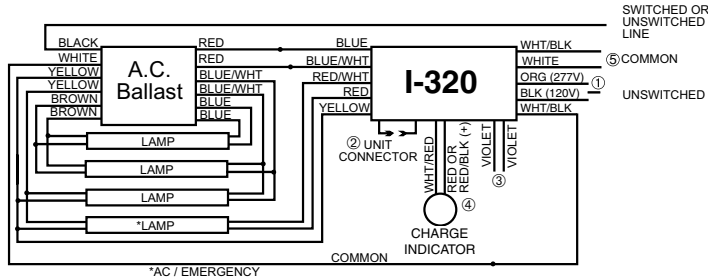

4. FOUR LAMP RAPID START BALLAST

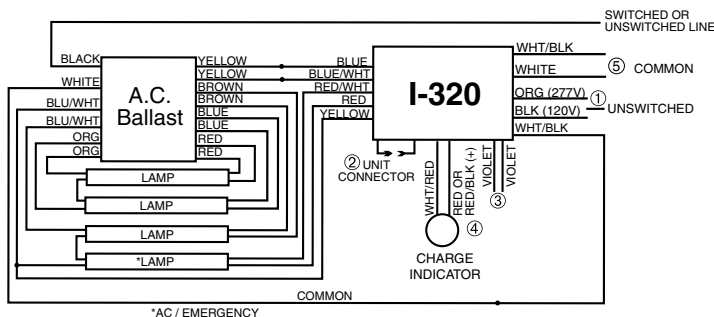

- ① SELECT PROPER VOLTAGE LEAD. CAP UNUSED LEAD. REFER TO AC INPUT WIRING ON ILLUSTRATION 3 OF INSTALLATION MANUAL FOR PROPER INPUT CIRCUIT WIRING.
- ② DO NOT MATE CONNECTOR UNTIL INSTALLATION IS COMPLETE AND AC POWER IS SUPPLIED.

- ③ LAMP SELECTOR LEADS—REFER TO INSTALLATION INSTRUCTIONS, LAMPS OPERATION SECTION FOR VARIOUS OPTIONS
- ④ TEST ACCESSORY LEADS—REFER TO INSTALLATION INSTRUCTIONS FOR PROPER POLARITY WIRING.

- ⑤ USE EITHER WHT/BLK LEAD FOR WIRING THE COMMON. REFER TO AC INPUT WIRING ON ILLUSTRATION 3 OF INSTALLATION MANUAL.
- ⑥ CONNECT BLU/WHT AND RED/WHT WIRES TOGETHER