

Thank you for purchasing IOTA's SDC1 Solid-DC Series Power Converter/Battery Charger. When utilized properly, your SDC1 Power Converter/Battery Charger will provide years of dependable service. This Owner's Manual contains important safety and operating instructions. **READ ALL INSTRUCTIONS AND SAFETY PRECAUTIONS CAREFULLY BEFORE INSTALLING AND OPERATING THE UNIT.**

## WARNING

### Risk of SERIOUS INJURY OR DEATH

This unit is an electrical device. When working with this, or any electrical device, there exists the potential for **ELECTRICAL SHOCK, EXPLOSION and FIRE hazards.**

Before using this equipment, **READ AND UNDERSTAND** the instructions, warnings, and safety precautions in this Owner's Manual. Failure to read and understand these instructions could result in **SERIOUS INJURY** or **DEATH.**

**SAVE THESE INSTRUCTIONS**

## CAUTION

**When working with the SDC1 unit, always observe the following guidelines:**

- The SDC1 is designed for indoor use. Do not use outdoors.
- **DO NOT** expose the SDC1 unit to rain, snow, or other inclement weather.
- Do not mount the SDC1 in a zero clearance compartment or in compartments with flammable items such as gasoline or batteries.
- Do not mount the SDC1 in an area with the potential of dust, debris, or other foreign materials entering the vents of the SDC1.
- Use of an attachment or device with the SDC1 not recommended by IOTA Engineering will void the warranty and may result in a risk of fire, electrical shock, or injury to persons.
- To reduce the risk of damage to the electric plug and cord, always pull by the plug and not the cord when disconnecting the unit.
- **DO NOT** operate the SDC1 with a damaged cord or plug.
- **DO NOT** operate the SDC1 if it has been dropped, received a sharp blow, or has been otherwise damaged in any way.
- **DO NOT** disassemble the SDC1 unit.
- To reduce the risk of electric shock, **DISCONNECT** the SDC1 charger from ALL power sources before attempting any maintenance or cleaning. Turning off any electrical supply or load to the unit is not sufficient and will not reduce this risk.
- **DO NOT** use extension cords. Using an improper extension cord could result in a risk of fire and electric shock, and may result in property damage, personal injury or death.

## DANGER

### ELECTRICAL SHOCK HAZARD

**THIS CHARGER IS AN ELECTRICAL DEVICE THAT CAN SHOCK AND CAUSE SERIOUS INJURY.**

**DO NOT CUT POWER CORDS.**

**DO NOT SUBMERGE IN WATER OR GET THE CHARGER WET.**

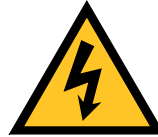

### EXPLOSION HAZARD

**UNSUPERVISED, INCOMPATIBLE, OR DAMAGED BATTERIES CAN EXPLODE IF USED WITH A CHARGER.**

**DO NOT ATTEMPT TO CHARGE DAMAGED OR FROZEN BATTERIES.**

**USE THE CHARGER ONLY WITH BATTERIES OF RECOMMENDED VOLTAGE.**

**OPERATE THE CHARGER IN WELL-VENTILATED AREAS ONLY.**



## WARNING

### FIRE HAZARD

**A CHARGER IS AN ELECTRICAL DEVICE THAT EMITS HEAT AND CAN BURN.**

**DO NOT COVER THE CHARGER.**

**KEEP THE CHARGER AWAY FROM COMBUSTIBLE MATERIALS.**

**DO NOT SMOKE OR USE ANY OTHER SOURCE OF ELECTRICAL SPARK OR FIRE WHEN OPERATING THE CHARGER.**



### RISK OF EXPLOSIVE GASES

**WORKING IN THE VICINITY OF LEAD-ACID BATTERIES IS DANGEROUS. BATTERIES GENERATE EXPLOSIVE GASES DURING NORMAL BATTERY OPERATION. FOR THIS REASON, IT IS OF UTMOST IMPORTANCE THAT YOU FOLLOW THE INSTRUCTIONS WHEN USING THE BATTERY CHARGER.**



To reduce the risk of battery explosion, follow these instructions and those published by the battery manufacturer and review all Cautions and Warnings associated with these products.

## PRODUCT DESCRIPTION

IOTA SDC1 Solid-DC Series Power Converter/Battery Chargers convert 120 volts nominal A.C. to 27.2 volts D.C. As a power supply, its tightly controlled regulation allows the user to operate any 24 volt nominal D.C. load up to the converter's rated output current. As a battery charger, the converter will maintain the battery, delivering its full-rated current when the battery capacity falls sufficiently low. The voltage is set to deliver its maximum current for the necessary period of time that minimizes undue stress to the battery caused by heating of its cells. This helps to ensure the longest possible life of the battery. Over time, as the battery nears its full capacity, the converter will float-charge the battery to prevent self-discharge of its cells.

## PROTECTION FEATURES

The IOTA Power Converters/Battery Chargers are designed with high quality components to help ensure years of continuous use. The unit is protected by multiple protection features for a long, trouble-free life.

1) *Reverse Battery Polarity Protection.* 2) *Brown-Out Input Protection.* 3) *Over-Current Protection* - cycle by cycle peak limiting as well as rated current limiting to maximize the life of the converter. 4) *Over-Temperature Protection.* In addition, it is designed with a unique "proportional" fan control circuit. Fan speed is directly proportional to the converter's internal ambient temperature. This enables the fan to turn on and off very slowly, minimizing unwanted fan-starting noise.

## INSTALLATION GUIDELINES

### MOUNTING LOCATION

The IOTA Power Converter/Battery Charger can be mounted in any position within an enclosed or interior compartment. Provide sufficient air space to allow unrestricted airflow in and around the unit. Provide at least 4" around the fan of the SDC1 to allow for proper air intake.

**DO NOT** mount the unit in a zero clearance compartment.

**DO NOT** mount the SDC1 in the same compartment with flammable items such as gasoline or batteries. There are no components within the SDC1 unit that, during normal operation, produce arcs or sparks. However, all electronic devices have some potential for generating sparks in the event of failure which can result in explosion or fire.

**DO NOT** mount the SDC1 in an area that has the potential of dust, debris, or other foreign materials to enter in through the SDC1 vents.

**DO NOT** place the SDC1 directly above the battery; the gases from the battery can corrode and damage the SDC1.

## INSTALLATION GUIDELINES (cont.)

### BATTERY CONNECTION

Before you connect the SDC1 to the battery, make sure that the AC power cord is NOT plugged into an electrical outlet.

Disconnect the positive side of the battery before installation. Connect the positive and negative terminal lugs to battery or load. Always use the proper size wire based on the amperage of the converter and the battery. Torque the connections to the proper rating according to the wire manufacturer's specifications. Refer to Illustration 1. Recreational vehicle applications require a type III circuit breaker be installed within 18" of the battery, connecting the battery positive to the line side of the breaker, and the IOTA unit to the load side. Connect "Chassis Bonding Lug" on the IOTA unit to vehicle chassis or other grounding source. Refer to Illustration 1.

### 120 VOLT A.C. INPUT

Plug the unit A.C. input cord into an appropriate 120-volt 3-wire grounded source. The blue LED indicator light will illuminate, indicating the presence of AC power. Refer to Illustration 2 for specifications of the cord provided with your SDC1 unit. See the Technical Specifications Chart on page 4 for maximum current draw and required input voltages.

**DO NOT USE EXTENSION CORDS** - Using an improper extension cord could result in a risk of fire and electric shock, and may result in property damage, personal injury or death.

**DO NOT OPERATE THE SDC1 WITH A DAMAGED CORD OR PLUG.** Have the cord or plug replaced immediately by qualified service personnel.

### REVERSE POLARITY FUSES

The IOTA Battery Charger/Power Supply is protected against reverse polarity on the DC output. If a battery or the unit is hooked up incorrectly, the fuses will blow and can be easily replaced. Always use the same size and style fuse that came with the converter.

**NOTE: Depending on the amperage model of the SDC1, fuses may not be present in all slots. Refer to the chart below for the rating and number of fuses per model:**

Model	Fuse Rating	Fuse Quantity
SDC1-120-24-15	7.5A	2
SDC1-120-24-25	15A	2
SDC1-120-24-40	20A	2

## WARRANTY



The IOTA Solid-DC Power Converters/Battery Chargers are warranted from defects in materials or workmanship for three years from date of retail purchase, and limits the remedies to repair or replacement. This warranty is valid only in the continental United States and Canada. For complete warranty details, contact Customer Service or visit [www.iotaengineering.com](http://www.iotaengineering.com).

### ILLUSTRATION 1 - SDC1 CONNECTIONS\*

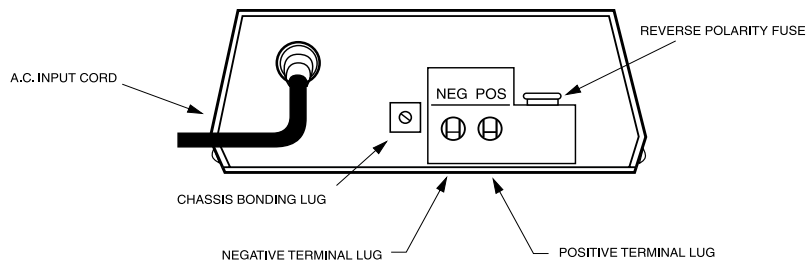

**Torque the connections to the proper rating according to the wire manufacturer's specifications.**

\*Actual component locations may vary depending on model.

### ILLUSTRATION 2 - AC INPUT PLUG

#### SDC1-120-24-15, SDC1-120-24-24

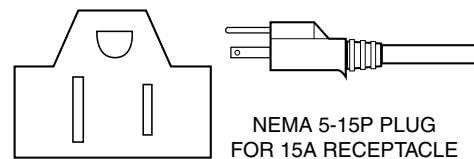

NEMA 5-15P PLUG FOR 15A RECEPTACLE

#### SDC1-120-24-40

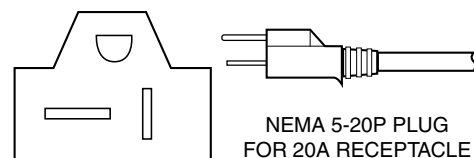

NEMA 5-20P PLUG FOR 20A RECEPTACLE

## ACCESSORY PORT AND AMPLIFE CHARGE CONTROL MODULE

The SDC1 features an accessory port on the fan end of the unit for installing an AmpLife Charge Control Module for automatic four-stage charging.

Installing the AmpLife Charge Control Module gives the user the benefit of automatic Bulk, Absorption, and Float stage charging. This increases the charging capacity of the IOTA charger, decreases charge times and insures proper and safe battery charging without over-charging. The green LED on the module will indicate which charging phase the IOTA charger is currently in. When the unit is first activated, the LED will flash as it reads the number of cells in the battery. The unit will then proceed directly to the Bulk charging or Float charging phase depending on the charge status of the battery. Use the LED CODE TABLE for reference when checking the LED.

To install an AmpLife module into the charger, remove the fastening screw on the top of the port faceplate and detach the faceplate. Plug the control module into the port and secure in place using the original fastening screw. NOTE: the port faceplate and AmpLife control module are similar in appearance. You can recognize the AmpLife Charge Control Module by the presence of the LED indicator on the face.

### ILLUSTRATION 3 - AMPLIFE MODULE INSTALLATION

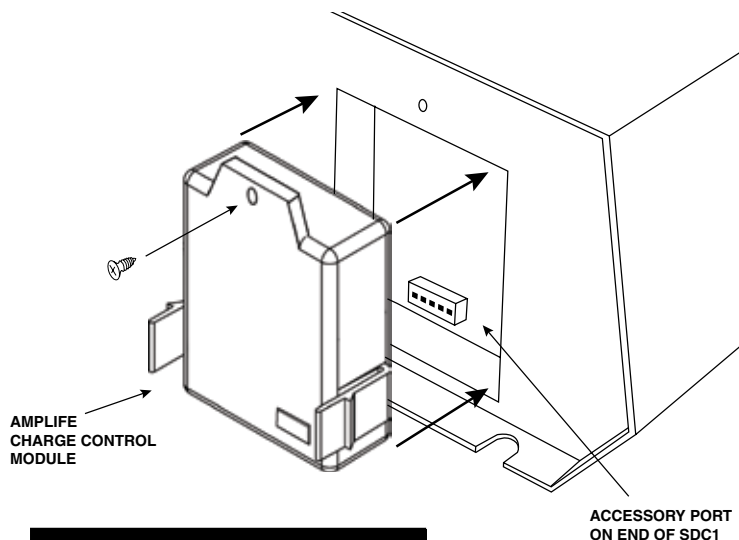

ACCESSORY PORT ON END OF SDC1

LED CODE TABLE		
<b>CELL INDICATION</b>		
6 FLASHES		12V Battery (6 cells)
12 FLASHES		24V Battery (12 cells)
18 FLASHES		36V Battery (18 cells)
24 FLASHES		48V Battery (24 cells)
<b>CHARGE PHASE</b>	<b>LED STATUS</b>	<b>VOLTAGE RATE</b>
FLOAT	ON	2.266 PER CELL
ABSORPTION	SLOW FLASHING	2.366 PER CELL
BULK	RAPID FLASHING	2.466 PER CELL

# TECHNICAL SPECIFICATIONS CHART

RATINGS AND SPECIFICATIONS	SDC1-120-24-15	SDC1-120-24-25	SDC1-120-24-40
DC Output Voltage (No Load) approx.	27.2V (DC)	27.2V (DC)	27.2V (DC)
Output Voltage Tolerance (No Load)	+ or - .5%	+ or - .5%	+ or - .5%
Output Amperage, Max Continuous	15 Amps	25 Amps	40 Amps
Output Voltage (Full Load) approx.	>27.0V (DC)	>27.0V (DC)	>27.0V (DC)
Maximum Power Output, Continuous	450 Watts	750 Watts	1200 Watts
Ripple and Noise	<100 mV rms	<100 mV rms	<50 mV rms
Input Voltage Range	108 - 132 AC	108 - 132 AC	108 - 132 AC
Input Voltage Frequency	47-63	47-63	47-63
Maximum AC Current (@ 108Vac)	7.3 Amps	12.2 Amps	19.5 Amps
Typical Efficiency	>80%	>80%	>80%
Max Inrush Current, Single Cycle	30 Amps	30 Amps	40 Amps
Short Circuit Protection	Yes	Yes	Yes
Overload Protection	>100%	>100%	>100%
Line Regulation	100 mV rms	100 mV rms	100 mV rms
Load Regulation	<1%	<1%	<1%
Fan Control	PROPORTIONAL	PROPORTIONAL	PROPORTIONAL
Thermal Protection	YES	YES	YES
Working Temperature Range	0° - 40° C	0° - 40° C	0° - 40° C
Storage Temperature	-20° to 80° C	-20° to 80° C	-20° to 80° C
Withstand Voltage (VDC) <sup>†</sup>	1700/1700/500	1700/1700/500	1700/1700/500
Approximate Dimensions	10.3" x 6.0" x 2.7"	10.3" x 6.0" x 2.7"	12.1" x 7.75" x 2.9"
Weight	4.0 lbs	4.5 lbs	8 lbs

\*Requires 30A breaker

<sup>†</sup>Primary to Chassis/Primary to Secondary/Secondary to Chassis

Distributed By:



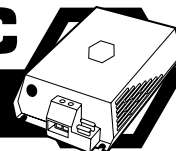

Merci pour votre achat du Convertisseur/Chargeur de batterie de la série d'IOTA Engineering. Lorsqu'il est utilisé correctement, ce Convertisseur/Chargeur de Batterie SDC1 pourra fonctionner pendant plusieurs années. Ce Manuel du propriétaire contient d'importantes instructions de sécurité et de fonctionnement. VEUILLEZ LIRE TOUTES LES INSTRUCTIONS ET LES PRÉCAUTIONS DE SÉCURITÉ ATTENTIVEMENT AVANT D'INSTALLER ET D'UTILISER L'UNITÉ.

## AVERTISSEMENT

### Risque de GRAVES BLESSURES OU DE MORT

Cette unité est un appareil électrique. Lors de son utilisation ou avec un quelconque autre appareil électrique, il existe des risques potentiels de **CHOC ÉLECTRIQUE, D'EXPLOSION OU D'INCENDIE**.

Avant d'utiliser cet équipement, veuillez LIRE ET COMPRENDRE les consignes, avertissements et précautions de sureté se trouvant dans le Manuel du Propriétaire.

La mauvaise lecture ou une mauvaise compréhension de ces consignes pourrait entraîner de GRAVES BLESSURES voire LA MORT.

**SAUVEGARDER CES INSTRUCTIONS**

## ATTENTION

Lorsque vous travaillez avec l'unité SDC1, veuillez respecter les directives ci-dessous:

- Le SDC1 est conçu pour une utilisation intérieure. Ne pas utiliser à l'extérieur.
- NE PAS exposer l'unité SDC1 à la pluie, neige ou autre intempérie.
- Ne pas monter le SDC1 dans un compartiment à tolérance zéro ou dans des compartiments avec des objets inflammables tels que de l'essence ou des batteries.
- Ne pas monter le SDC1 dans une zone où de la poussière, des débris ou autres matériaux parasites pourraient entrer dans les conduits du SDC1.
- L'utilisation d'une attache ou d'un appareil avec le SDC1 n'est pas recommandée par IOTA Engineering qui annulera la garantie. Il y a également des risques d'incendie, de choc électrique ou de blessures sur personne.
- Afin de réduire le risque de dommage sur la prise et le fil électrique, veuillez tirer sur la prise, et non le fil lorsque vous débranchez l'unité.
- NE PAS utiliser le SDC1 avec un fil ou une prise endommagée.
- NE PAS utiliser le SDC1 s'il est tombé, a reçu un coup ou a été endommagé d'une manière ou d'une autre. Amenez l'unité SDC1 auprès d'un endroit de service agréé.
- NE PAS démonter l'unité DSL. Amenez l'unité SDC1 auprès d'un endroit de service agréé lorsqu'un service ou une réparation est requise.
- Afin de réduire le risque de choc électrique, DÉBRANCHEZ le chargeur SDC1 de TOUTES les sources de courant avant d'effectuer tout nettoyage ou maintenance. Couper tout courant ou charge électrique vers l'unité n'est pas suffisant et ne réduira pas le risque.
- NE PAS utiliser de rallonge. L'utilisation d'une mauvaise rallonge pourrait résulter en un risque d'incendie ou un choc électrique et pourrait résulter endommager les biens, causer des blessures personnelles voir la mort.

## DANGER

### RISQUE DE CHOC ÉLECTRIQUE

**CE CHARGEUR EST UN APPAREIL ÉLECTRIQUE QUI PEUT CAUSER UN CHOC ET DES BLESSURES GRAVES.**

**NE PAS COUPER LES FILS ÉLECTRIQUES.  
NE PAS SUBMERGER D'EAU OU MOILLER LE CHARGEUR**

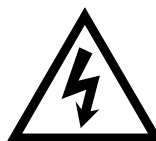

### RISQUE D'EXPLOSION

**DES BATTERIES NON-SUPERVISÉES, INCOMPATIBLES OU ENDOMMAGÉES PEUVENT EXPLOSER SI ELLES SONT UTILISÉES AVEC UN CHARGEUR.**

**NE PAS ESSAYER DE CHARGER DES BATTERIES ENDOMMAGÉES OU GELÉES.**

**UTILISER SEULEMENT LE CHARGEUR AVEC DES BATTERIES AU VOLTAGE RECOMMANDÉ.**

**UTILISER LE CHARGEUR SEULEMENT DANS DES ZONES BIEN VENTILÉES.**



## AVERTISSEMENT

### RISQUE D'INCENDIE

**UN CHARGEUR EST UN APPAREIL ÉLECTRIQUE QUI ÉMET DE LA CHALEUR ET PEUT BRULER.**

**NE PAS COUVRIR LE CHARGEUR.**

**CONSERVER LE CHARGEUR HORS DE PORTÉE DE MATÉRIAUX COMBUSTIBLES.**

**NE PAS FUMER OU N'UTILISER AUCUNE AUTRE SOURCE D'ÉTINCELLE ÉLECTRIQUE OU DE FEU LORSQUE VOUS UTILISEZ LE CHARGEUR.**



### RISQUE DE GAZ EXPLOSIFS

**TRAVAILLER AVEC DES BATTERIES PRINCIPALEMENT EN ACIDE EST DANGEREUX. LES BATTERIES GÉNÈRENT DES GAZ EXPLOSIFS DURANT LE FONCTIONNEMENT NORMAL DE LA BATTERIE. DE CE FAIT, IL EST EXTRÊMEMENT IMPORTANT QUE VOUS SUIVIEZ LES INSTRUCTIONS LORSQUE VOUS UTILISEZ LE CHARGEUR DE BATTERIE.**

Afin de réduire le risque d'explosion de la batterie, veuillez suivre ces instructions ainsi que celles publiées par le fabriquant de batterie et veuillez revoir tous les Avertissements et Dangers associés à ces produits.

